

Other products

Linear motion	678
■ AXC compact modules	679
■ AXLT linear tables	680
■ AXS systems modules	680
■ Specific solutions	681
Special bearings	682
■ Description and capabilities	682
■ Series	684
■ Individualized solutions	686
<i>Ball bearings units</i>	686
<i>Split housing units</i>	687
<i>Complete systems</i>	687
Aerospace	688
Automotive	689
Railway applications	690
Other applications	691
■ SNR and quarries – mines	691
■ SNR and paper mill industry	692
■ SNR and steel industry	692
■ SNR and agri-food industry	693



Linear motion

The range of SNR linear modules and tables offers many solutions for production automation, notably in assembly, measurement or handling sectors.

■ The modular, flexible design allows us to propose a type of drive and guidance function perfectly tailored to each application, with extensive specific adaptation capabilities. High quality components guarantee optimum service lives and reliability. Finally, low product footprint facilitates installation in all types of mechanical systems.

The SNR technicians at our design offices provide technical support during solution-finding and recommendation phases.

All SNR linear motion units are developed, manufactured and tested in our Bielefeld workshop (Germany). Linear module production has been certified since January 2000 to DIN EN ISO standard 9001:2000. If application requires, modules can be assembled under protected environment, in a clean room.

SNR linear modules address the most diversified application in various industrial sectors: automation, machine-tools, electrotechnology, electronics, motor industry, printing, special machine construction, white rooms in semi-conductor and food industries.

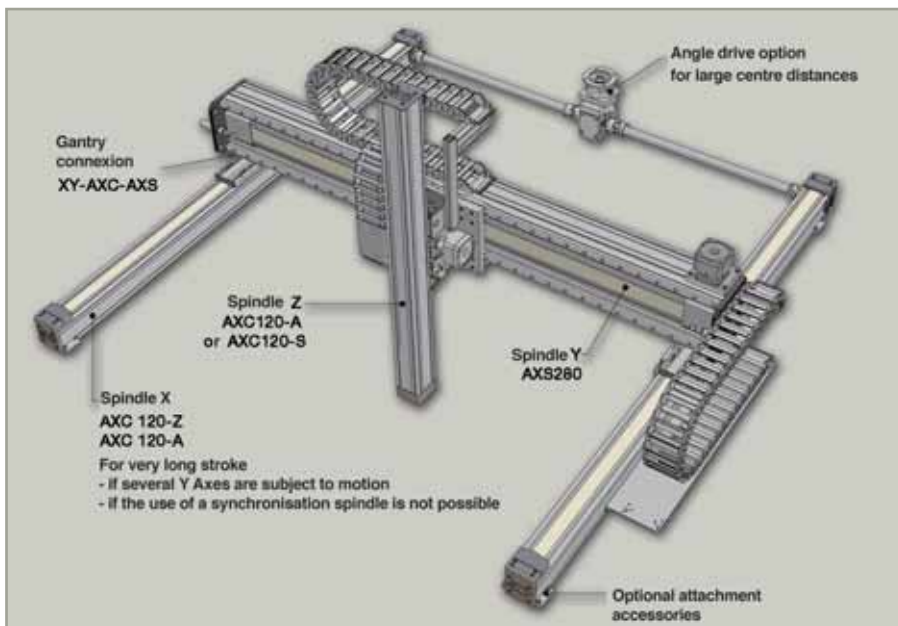

■ The linear motion range breaks down into three complementary families:

- **AXC compact modules:** based on open sections integrating guiding and driving functions for general applications.
- **AXLT linear tables:** for applications requiring accuracy and stiffness.
- **AXS system modules:** based on close sections, tailored to heavy load handling applications.

AXC compact modules

The range of AXC compact modules is built on 40, 60, 80 and 120 mm aluminium sections. These products feature versatility and compactness. They can be used either singly or interconnected thanks to a range of interconnection components allowing multi-axis assembly creation.

■ Various guide / drive variants are proposed to adapt the mechanical solution to each application:

- Roller drive or various types of rails / boltage cursors
- Ball screw or notched belt drive

Screw type drive

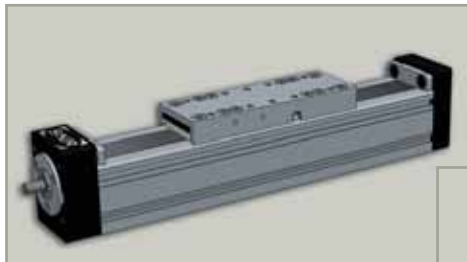

Toothed belt drive

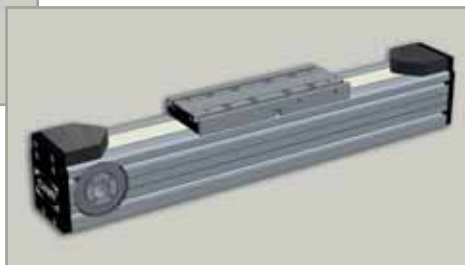

■ Various suitable optional items are proposed:

Protection strip, pre-tensioning, clamps and coupling for motor mount, integral reduction gears, limit switches, ...



Linear motion *(suite)*

AXLT linear tables

■ AXLT series linear tables are tailored to high load applications requiring good accuracy. The standard range is built on 155, 225, 325 and 455 mm wide aluminium support plates. For applications where the table plays a structural role, the base plates can be delivered in steel construction.

Carriage drive is ensured by ball screws or trapezoidal thread screws. Loads are sustained by engaged ball guides. These mechanical components are protected from outside environment by boots.

■ **Optional items are available:** sensors, motor coupling and flanges, belt angle drive,...

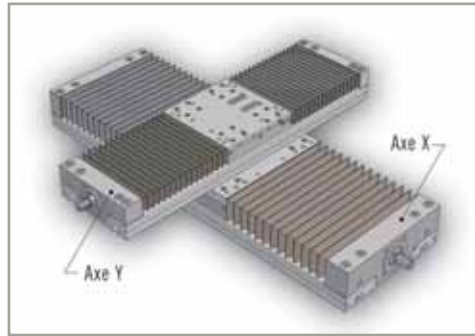

AXS system modules

■ AXS modules are required to handle heavy loads. The range breaks down into horizontal gantries, vertical lifting modules and telescopic modules.

Horizontal modules are based on large-section closed aluminium beams with high capacity ball-type guide pads and a belt or rack drive system. These modules can move loads up to 6,000 Kg with cantilever lengths (overhang) up to 10 m.

For vertical motion, lifting modules can displace loads up to 1,000 Kg thanks to reinforced gear-rack systems. Design allows use of these modules on long spans, with various moving carriages, independent from one another.

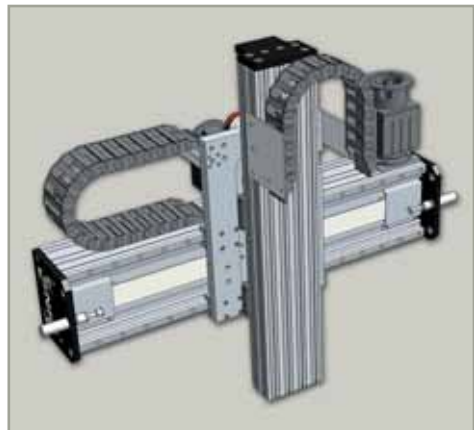

Finally, telescopic modules can be used for vertical or horizontal displacements requiring low footprint. Design allows very high travelling rates (up to 10 m/s).

All AXS range modules can easily be combined to compose full-featured assemblies by integrating various optional items (position sensors, pods, cable carrier chains, ...)



Specific solutions

■ In addition to the standard range, SNR proposes solutions addressing high technology applications which require specific technical solutions.

Notably, the standard range can be adapted to address particular environmental requirements, such as in white rooms or in agri-food systems. When standard solutions are not suitable, the SNR design office is at your disposal for designing specific solutions tailored to your own needs.



Special bearings

Description and capabilities

■ The design office engineers and technicians are trying constantly to improve the technical and economic performance of their products by expanding their limits.

SNR has found that the synergy obtained by working hand-in-hand with our customers results in original and innovative approaches to rotational functions that can remove some of the constraints limiting their products.

A fruitful collaboration must be tangible at all levels : technical creativity, lasting economic competitiveness and industrial responsiveness. SNR has dedicated the necessary human and material resources to meet the design, production and commercial requirements of such collaborations:

- All developments follow our ISO 9001 certified procedures
- Prototypes and pre-production models can be rapidly produced to validate calculated performance. If necessary, a test centre is available to test variants of your products.
- An industrialization and production unit, which is specialized for small and medium quantities, can devote the necessary attention to the particular details of your product.



- Field service augmented by powerful technical support groups facilitate product integration into its application.
- Product and service quality require reciprocal commitments. For this purpose, SNR proposes a cooperation agreement which details these commitments and provides an additional guarantee of success.









■ The agreement is grounded on a program based on previous issues, whatever the industry or branches where special SNR bearings are used. The special products developed by SNR directly benefit from State-of-the-Art innovations from our research & development plan.

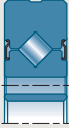

Special bearings (continued)

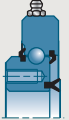
Series

■ Comparative table of different bearing types

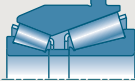
Product		Market	Capabilities	
Type		Examples of applications	Radial load	Axial load
QR		Robotics, special reducing gears, civil engineering, mines, transport, telecommunications, agricultural machinery, railway applications.		
QJ		Automatic systems, robotics, special reducing gears, civil engineering, mines, transport, handling, agricultural machinery, railway applications.		
AB		Transport, agricultural machinery, textiles, material handling, lifting, reducing gears, railways applications, food industry, machine-tools, pump-turbines, chemical industry, cam and conveyor rollers.		
GB		Transport, civil engineering equipment, mines, textiles, agriculture, food industry, material handling, reducing gear, gearboxes.		
N		Transport, agricultural machinery, iron and steel industry, printing, civil engineering, railway applications, textiles.		
GNU		Iron and steel industry, food industry, reducing gears, conveyors, railway applications, civil engineering.		
FC		Transport, railway applications, iron and steel industry, agriculture, civil engineering, mines, material handling.		

Our applications engineers will determine the SNR solution that the best meets your requirements.

- QR** : crossed roller bearings
- QJ** : ball bearings with 4 contact points
- AB** : single-row ball bearings
- GB** : double-row angular contact ball bearings TWINLINE
- N** : cylindrical roller bearing
- GNU** : single or double-row cylindrical roller bearing with a large outer ring
- FC** : double tapered bearings

Capabilities			Additional Characteristics				
Speed of rotation	Canting moment	Friction moment	Lubrication	Protection	Adjustment	Connection	Transmission
Average	Average	Average	Average	Average	Average	Average	Average
Good	Good	Good	Good	Good	Good	Good	Good
Average	Average	Average	Average	Average	Average	Average	Average
Good	Good	Good	Good	Good	Good	Average	Average
Average	Average	Average	Average	Average	Average	Average	Average
Average	Average	Average	Good	Good	Good	Good	Average
Average	Average	Average	Average	Average	Average	Average	Average

Excellent  Good  Average  Poor 



Special bearings *(continued)*

Customized solutions

→ Self-aligning bearings

In addition to a very extensive range of standard self-aligning bearings, SNR can propose solutions tailored to your requirements and help you face the challenges in terms of bearing applications.

Together with highly diversified raw material choices such as grey iron, modular iron, cast steel, steel sheet or plate, or thermoplastic resin, SNR can also propose tailor-made designs.

Efficient sealing systems which ensure suitable bearing operation were specially developed for our clients.

Bearing and insert surface protection is ensured thanks to high performance processes such as nickel plating or galvanising.

SNR bearings can be painted, coated by spraying process or finished following innovative methods.

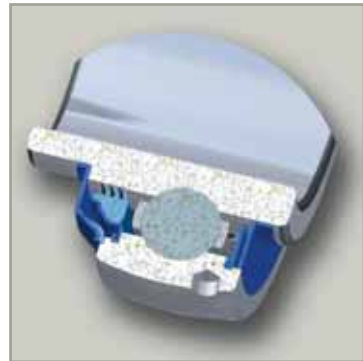

→ Split housing units

Special applications require special concepts.

For example, SNR proposes base plate bearing units for high load requirements such as mining, or industrial fan bearings in cement mills. Through its extensive technological knowledge of bearings and long experience in this sector, SNR has become the ideal partner.

In addition to standard designs, we can propose customized solutions designed to enhance our clients' machine performance and service life.

We have integrated many environment criteria and optimised, amongst others, the bearing sealing systems. We have also equipped the bearings with oil circulation or vapour lubrication devices.

As for self-aligning bearings, pillow block housings can be manufactured on demand, from modular iron or steel casting.

We develop and manufacture tailored bearing variants allowing perfect integration into your applications.

We also propose particularly attractive and competitive turnkey solutions comprising tailor-made bearing-bearing unit-shaft assemblies to be installed directly.



→ Complete systems

One of SNR's main assets is its capacity to develop system solutions in cases where standard solutions are not applicable.



Beyond the bearing's main function, we take into account mechanical interfaces, thereby simplifying integration into the existing system. This cost-saving approach also reduces commissioning times and incorrect assembly errors.

Your single source: SNR.



Aerospace

Aerospace: SNR on board means comfort

Today, SNR bearings are chosen in the major aerospace programmes: Airbus, Boeing, Dassault, Ariane 5 European launcher... they all use engines equipped with SNR bearings. Likewise, helicopter manufacturers are proud to rely on the European leader of helicopter transmission bearings.

The significant resources assigned to R&D and tests by SNR and a good comprehension of specifications have enabled the company to meet the increasing requirements of its clients for more than 50 years.

Quality, reliability and efficient organisation have positioned SNR amongst the major leaders of the Aerospace sector worldwide.



Production methods and means, high training and qualification have enabled our Aerospace division to obtain quality certificates from the major Aeronautics manufacturers.

Aerospace requires the highest performance bearings with highest reliability. Turbojet and turboshaft engines expose the bearing to high speeds, high temperatures, while requiring weight savings. In helicopter transmissions, bearings are subject to high loads, vibrations and structural deformation.

As a complement to OEM activity, SNR aerospace has obtained the required approvals delivered by civil aviation authorities (JAA, FAA, CAAC) to propose to engine and aircraft operators and after-sales facilities a wide range of services broken down into two main categories:

- aerospace bearing maintenance.

The "SNR MRO Services" offer, exhaustively addresses the requirements of engine maintenance facilities, either affiliated with airlines, OEM's, or independant contractors.

- aftermarket spares.

Automotive

Automotive: the European reference

■ In the world of motor car and OEM manufacturers, the conventional "supplier" was replaced by a concept of "cooperating company", leading the suppliers and their clients to jointly work and develop common technologies and synergies. SNR is one of the major cooperating companies in the automotive sector and this cooperation process is deeply rooted in its culture. With bearings present in 8 of the 10 best selling cars in Europe, SNR clearly identifies itself as the European leader of wheel bearings.



SNR follows the worldwide market evolution and acts as a privileged contact for the leading motorcar and OEM manufacturers, covering the whole range of motor and bearing applications:



- ▶ Wheel bearings, 1st, 2nd and 3rd generations
- ▶ Chassis
- ▶ Gearbox
- ▶ Transmission shafts
- ▶ Steering column
- ▶ Engines and accessories

SNR created ASB® (Active Sensor Bearing), an instrumented bearing which has become a worldwide standard, illustrating the company's involvement in automotive sector progress and development. The ASB® technology has now been adopted by all the world leaders in the bearings sector in Europe and Japan.

This technology is a decisive contribution to design and implementation of State-of-the-Art technologies referred to as "mechatronics", which currently change the conventional vehicle concepts and provide the driver with a leading-edge advantage in terms of safety and performance.

Our technical competence and know-how are also at your disposal for the Aftermarket, which directly benefits from SNR's prevailing position in the OEM sector as well as its genuine product offer.



Rail

SNR solutions : the future on rails

■ SNR solutions : the future on rails

SNR, at the very heart of big European rail projects for more than 40 years. Its cutting edge technological know-how has made it the indispensable partner of the main international players in OEM and AFT (aftermarket).

After giving our contribution to the TGV's world speed record at 574.8 km/hr with our bearings in all TGV components (bearing axle boxes, transmissions and electrical drive motors), SNR is the first bearing manufacturer officially approved at 350 km/hr for axle bearings.

To efficiently meet the strong expectations from our clients, taking into account extreme conditions incurred by the bearings, SNR implements best technical solutions (materials, design, and also develops innovative processes for surface treatments such as phosphating, copper plating or nitriding.

SNR also allows you to benefit from its reliable maintenance analysis tools.

To optimize solution integration and to ensure the excellence and responsiveness of its maintenance services: fitting advice and assistance on site, assembly of series solutions on site, bearing training, axle blocks bearings maintenance and reconditioning...

**574.8 km/h: a record,
the proof of excellence**

Wheel axle bearings 100 % supplied by SNR.
On 17th April 2007 the French TGV East line broke world rail speed record at 574.8 km/h.
SNR took an active part in this record: all wheel axle boxes were equipped with SNR bearings.
SNCF and ALSTOM have trusted SNR for more than 20 years and have chosen us as development partner.



For more information, ask for our brochure dedicated to this sector.

Other applications

Our capacity to design bearings which integrate complementary, innovative functions (instrumentation, solid lubrication, ...) and our dedication to work in cooperation with our clients to pool our competences are the reasons for our presence in the major industrial markets and in higher diversified applications. From textile to rail and including film drawing machines, paper mills, iron & steel, agri-food, or even farming and bobbin-winding machinery..., SNR is present everywhere.

SNR and quarries - mines

■ The SNR career in quarries... The most severe applications

The work done in a quarry is more than just the extraction of the ore. A complete mechanical process is required to obtain a product with a specific granularity: crushing, grinding, screening process.

Heavy radial load, contamination, shocks, unbalanced load, vibration, high temperatures that can exceed 100°C (212°F), low rotating speed, misalignments: these are environmental constraints of a quarry.



SNR offers an extensive line of product, particularly PREMIER spherical roller bearings in steel cage or machined brass cage (or in special shaker screen, EF800 series) to withstand difficult operating conditions.

For each step in the ore process, SNR has just the right bearing.



For more information, ask for our brochure dedicated to this sector.



SNR and paper mill industry

■ SNR bearings: the sense of the fiber...

The transformation of a tree trunk into spotless paper requires a large number of operations. Working and treating the fibrous mass resulting from the wood involves the use of numerous machines, in which bearings are key components.

The paper environment is particularly difficult : presence of water and hot steam, high speeds of rotation and heavy loads, need for rotational accuracy, high temperature, aggressive chemical products particularly during the bleaching process, dust...



To face the numerous constraints in this sector, SNR proposes a range of bearings addressing the needs of paper mills, the Premier spherical roller bearings.

For accessory application (pumps, motors,...), our range of standard bearings is perfectly adapted.

SNR offers the paper mill Industry the appropriate solution for each step of the papermaking process.



For more information, ask for our brochure dedicated to this sector.

SNR and steel Industry

■ SNR bearings: as strong as iron & steel

Steel Industry process consists in transforming rough ore into value added steel, which have precise characteristics.

Due to high temperatures and loads, this sector imposes unmatched requirements on bearings.



The application conditions supported by the bearings are variable but always very difficult: very high pressures (rolling), high temperatures and heavy loads, humidity (water projection cooled the high temperature parts), vibration and shocks.

SNR develops products interchangeable with those in your machines :

- either standard bearings with performance optimized by shields or seals and appropriate clearance and grease;
- or, our special bearings designed to meet your specific needs, with identical dimensions to those of the bearings currently in place: no modifications are required.

The EF800 Premier spherical roller bearings for conveyors, shaker screen applications. The pillow block housing SNC bearings and the SNR carrier rollers and drive rollers are also major assets for your iron and steel equipment.



For more information, ask for our brochure dedicated to this sector.

SNR and agri-food industry

■ **SNR bearings: the indispensable ingredient in the agri-food process**

New ingredients, new modes of consumption, new preservation processes, the food industry is a fast-changing market. The industrial facilities must maintain high performance and reliability to guarantee sustained productivity.

In the agri-food industry, bearings must perform in: high and low temperatures, wet areas and water splashing, vibrations, misalignment...

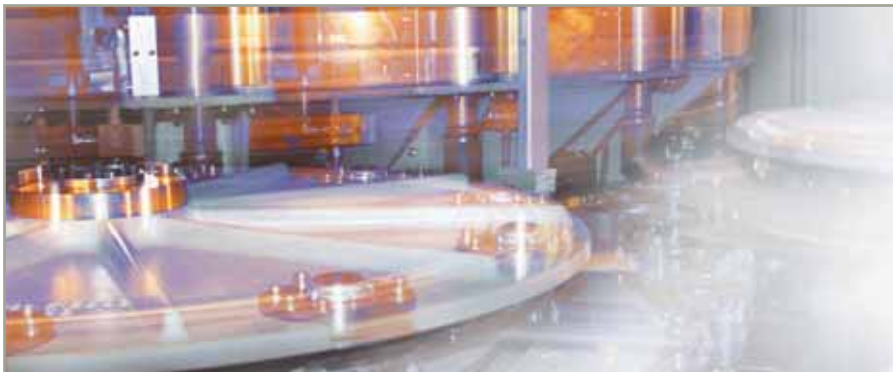

SNR has been present for years in many agri-food systems. Each trade has its own particulars requiring specific solutions in regards to bearings. Therefore, all SNR products have mechanical, thermal and chemical properties which address these requirements. Our TOPLINE range, our stainless steel bearings and bearing units meet all your expectations.



For more information, ask for our brochure dedicated to this sector.

